



Our Focus is in Plastics

Polymer Optics Ltd.

6 Kiln Ride, Wokingham,
Berks., RG40 3JL, England
Tel/Fax: +44 (0) 1189 893341
www.polymer-optics.co.uk

Narrow Angle Collimator for Avago Moonstone LEDs - Part No. 170



- Designed for Avago Moonstone High Power LED's
- High light collection efficiency of >85%
- Precision moulded in optical grade Polycarbonate for thermal stability and system durability
- Part of the Polymer Optics "Modular LED Optics"® range

Supplied with Holder (Part No. 182) to mount optics directly on to the Moonstone LED.

Holder locates on LED package to ensure correct optical alignment

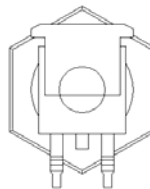

Typical dimensional tolerances to +/-0.2mm

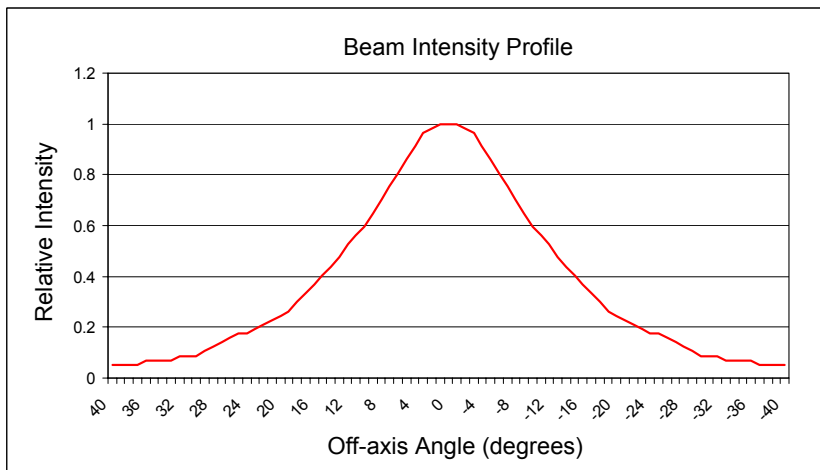
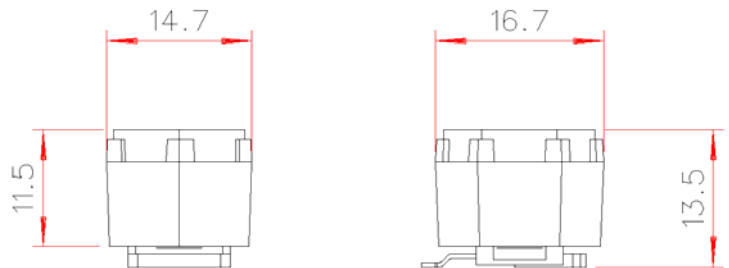
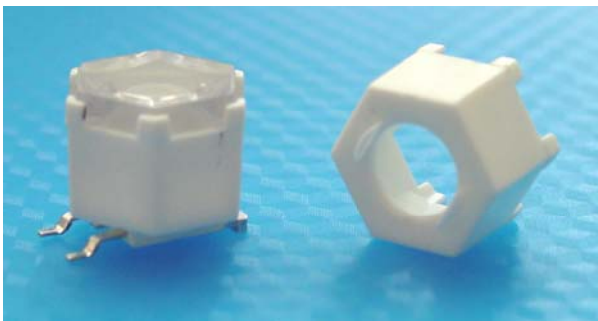

The 170 Narrow Angle Collimator can be used with both Standard and Diffuse Moonstone LEDs.

With Standard Moonstone LEDs the 170 optic may highlight some colour separation and imaging effects of the LED die, so is best used with the Diffuse package LED type.

However, the 186 Diffuse Narrow Angle Collimator optic gives an improved performance with all Moonstone LED types.

Due to continuous product improvement, POL reserve the right to change specifications without notice.



**Polymer
Optics
Limited**

Our Focus is in Plastics

Polymer Optics Ltd.

6 Kiln Ride, Wokingham,
Berks., RG40 3JL, England
Tel/Fax: +44 (0) 1189 893341
www.polymer-optics.co.uk

Wide Angle Collimator for Avago Moonstone LEDs - Part No. 171



- Designed for Avago Moonstone High Power LED's
- High light collection efficiency of >85%
- Precision moulded in optical grade Polycarbonate for thermal stability and system durability
- Part of the Polymer Optics "Modular LED Optics"® range

Supplied with Holder (Part No. 182) to mount optics directly on to the Moonstone LED.

Holder locates on LED package to ensure correct optical alignment

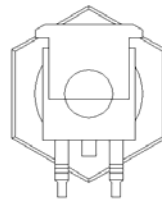

Typical dimensional tolerances to +/-0.2mm

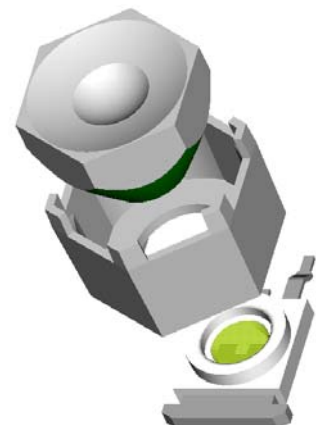
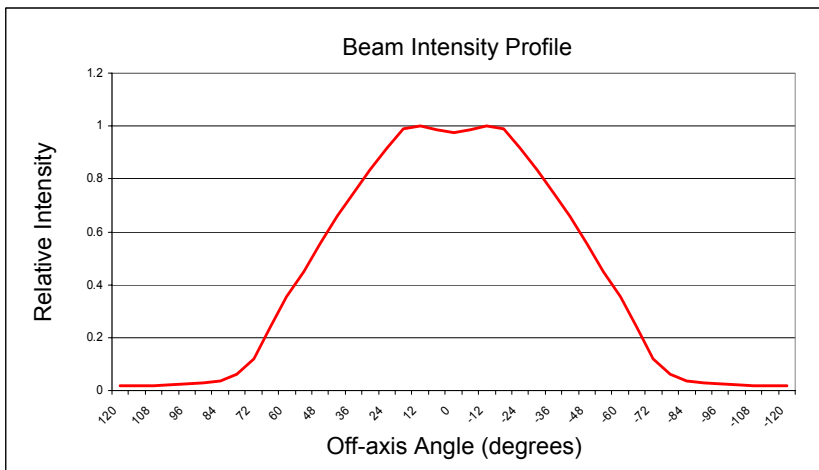
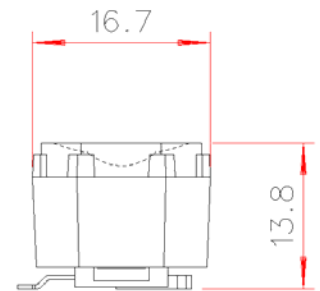
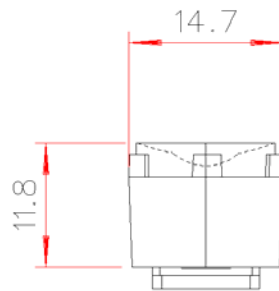
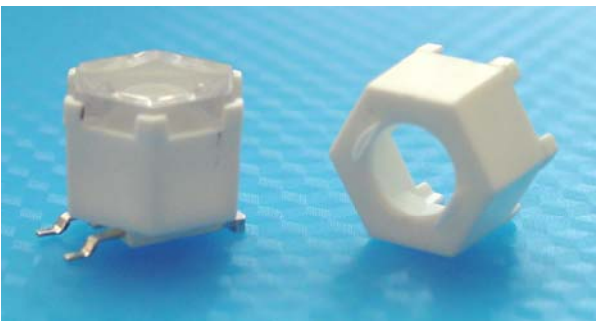

Due to continuous product improvement, POL reserve the right to change specifications without notice.

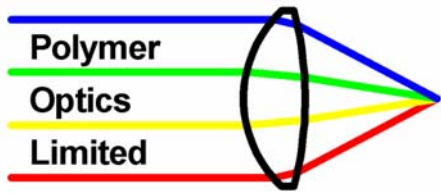

Our Focus is in Plastics

Polymer Optics Ltd.

6 Kiln Ride, Wokingham,
Berks., RG40 3JL, England
Tel/Fax: +44 (0) 1189 893341
www.polymer-optics.co.uk

Elliptical Beam Lens for Avago Moonstone - Part No. 172

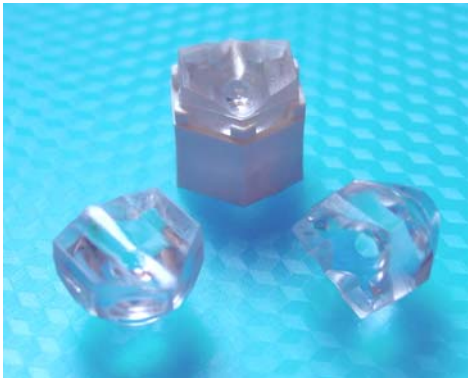

- Designed for Avago Moonstone High Power LED's
- High light collection efficiency of >85%
- Precision moulded in optical grade Polycarbonate for thermal stability and system durability
- Part of the Polymer Optics "Modular LED Optics"® range

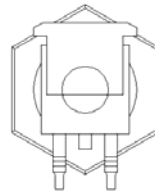

Typical dimensional tolerances to +/-0.2mm

Supplied with Holder (Part No. 182) to mount optics directly on to the Moonstone LED.

Holder locates on LED package to ensure correct optical alignment

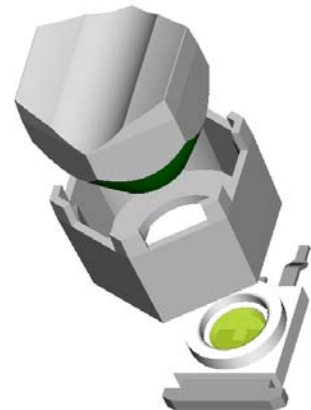
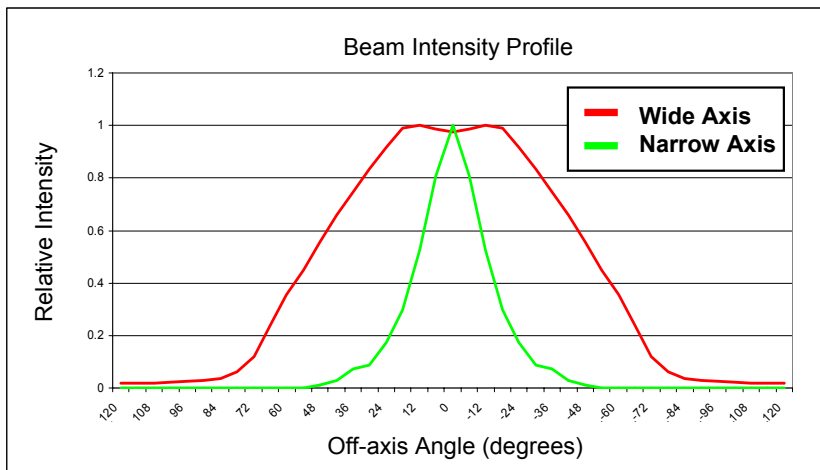
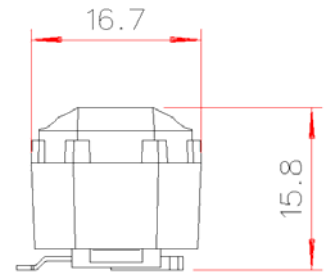
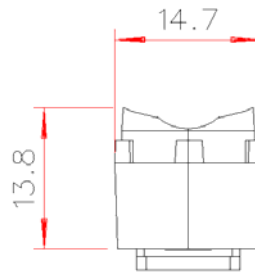
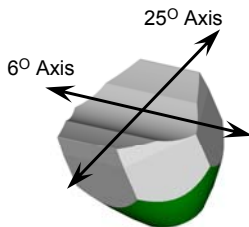

Due to continuous product improvement, POL reserve the right to change specifications without notice.



Our Focus is in Plastics

Polymer Optics Ltd.

6 Kiln Ride, Wokingham,
Berks., RG40 3JL, England
Tel/Fax: +44 (0) 1189 893341
www.polymer-optics.co.uk

Single Cell Concentrator Lens for Avago Moonstone LEDs - Part No. 173

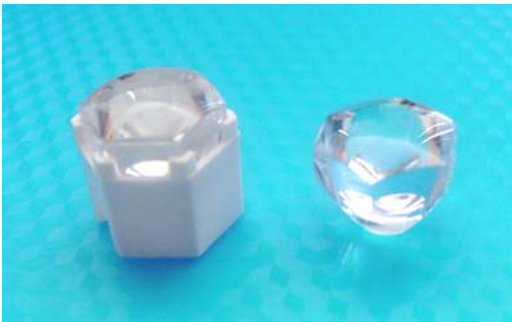

- Designed for Avago Moonstone High Power LED's
- High light collection efficiency of >85%
- Precision moulded in optical grade Polycarbonate for thermal stability and system durability
- Part of the Polymer Optics "Modular LED Optics"® range

Supplied with Holder (Part No. 182) to mount optics directly on to the Moonstone LED.

Holder locates on LED package to ensure correct optical alignment

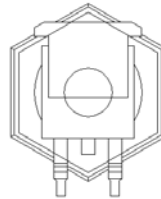

Typical dimensional tolerances to +/-0.2mm

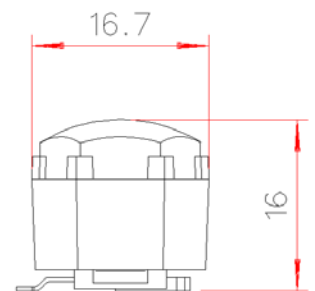
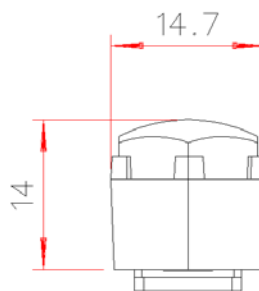
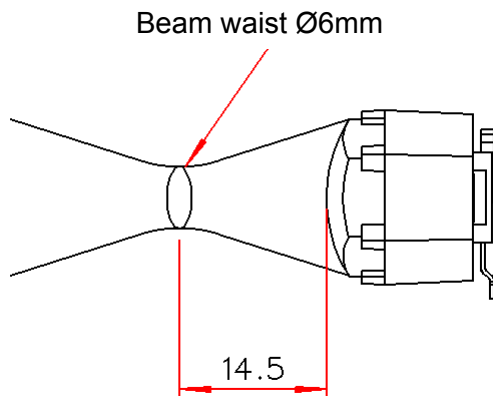

Typical Applications:

- Beam insertion into optical fibre bundles
- Beam insertion into edge of lightguides
- High intensity illumination of small objects for inspection and microscopy

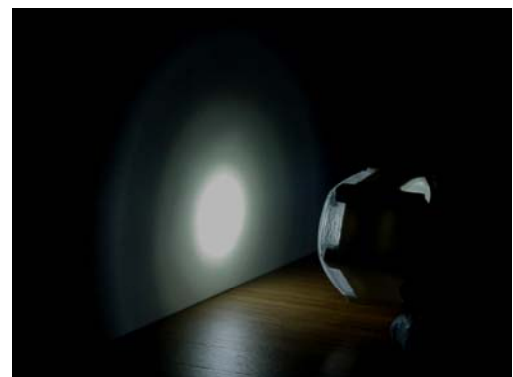



Our Focus is in Plastics

Polymer Optics Ltd.

6 Kiln Ride, Wokingham,
Berks., RG40 3JL, England
Tel/Fax: +44 (0) 1189 893341
www.polymer-optics.co.uk

Diffuse Narrow Angle Collimator for Avago Moonstone LEDs - Part No. 186



- Designed for Avago Moonstone High Power LED's
- High light collection efficiency of >85%
- Precision moulded in optical grade Polycarbonate for thermal stability and system durability
- Part of the Polymer Optics "Modular LED Optics"® range

Supplied with Holder (Part No. 182) to mount optics directly on to the Moonstone LED.

Holder locates on LED package to ensure correct optical alignment

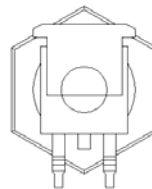

Typical dimensional tolerances to +/-0.2mm

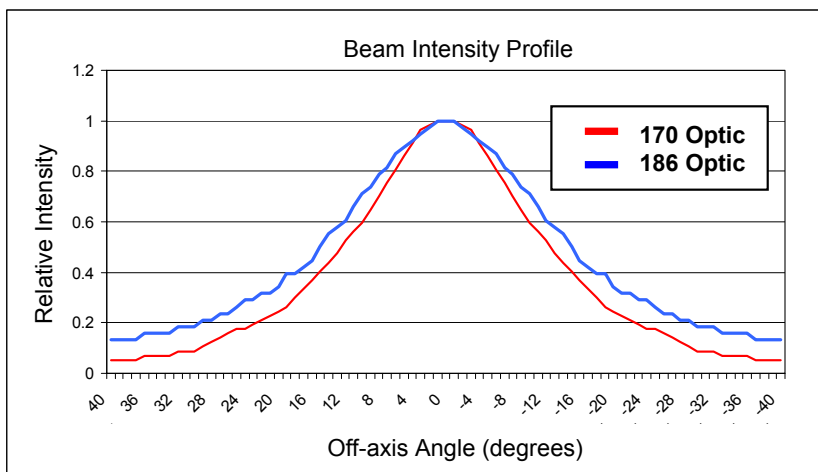
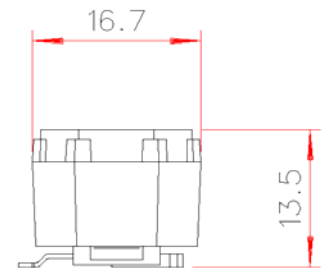
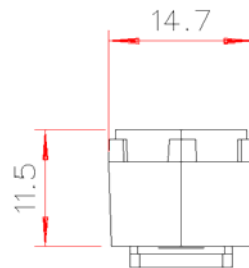
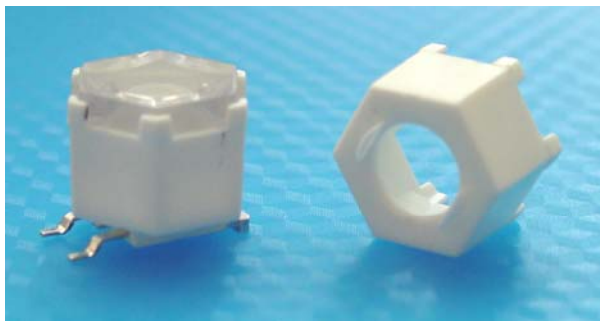

The 186 Diffuse Narrow Angle Collimator can be used with both Standard and Diffuse Moonstone LEDs.

With Standard Moonstone LEDs the 186 optic will provide improved colour uniformity than the 170 optic and reduce imaging effects of the LED die.

Similarly, the 170 optic gives best performance with the Diffuse Moonstone LED types

Due to continuous product improvement, POL reserve the right to change specifications without notice.



Our Focus is in Plastics

Polymer Optics Ltd.

6 Kiln Ride, Wokingham,
Berks., RG40 3JL, England
Tel/Fax: +44 (0) 1189 893341
www.polymer-optics.co.uk

15 Degree Collimator Lens for Avago Moonstone LEDs - Part No. 198



- Designed for Avago Moonstone High Power LED's
- High light collection efficiency of >85%
- Precision moulded in optical grade Polycarbonate for thermal stability and system durability
- Part of the Polymer Optics "Modular LED Optics"[®] range

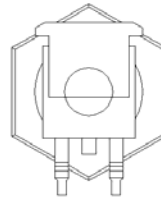
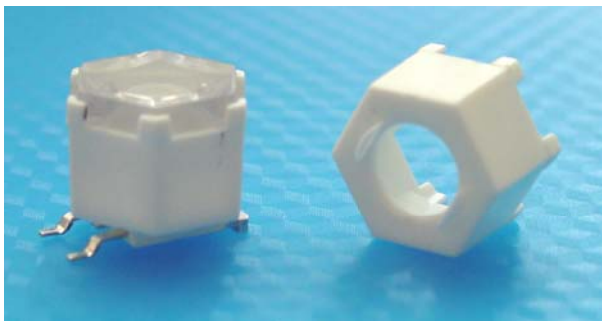

Typical dimensional tolerances
to +/-0.2mm

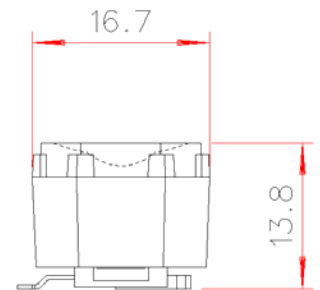
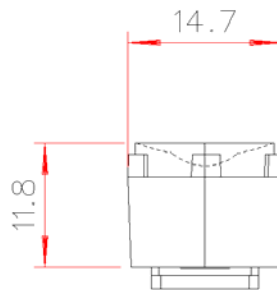

Polymer Optics "Modular LED Optics"[®] design, based on a hexagonal format, allows maximum packing density and assembly flexibility

Supplied with Holder (Part No. 182) to mount optics directly on to the Moonstone LED. Holder locates on LED package to ensure correct optical alignment



Our Focus is in Plastics

Polymer Optics Ltd.

6 Kiln Ride, Wokingham,
Berks., RG40 3JL, England
Tel/Fax: +44 (0) 1189 893341
www.polymer-optics.co.uk

Diffuse 6x25 Degree Collimator Lens for Avago Moonstone LEDs - Part No. 218

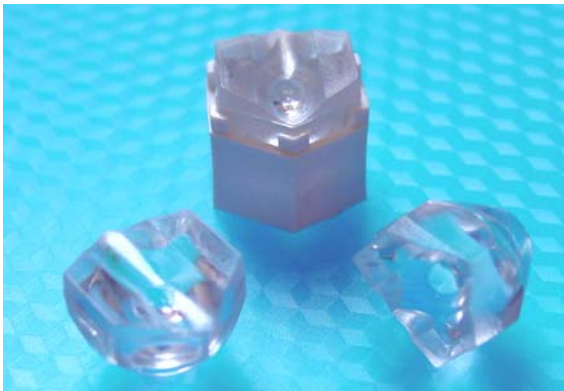

- Designed for Avago Moonstone High Power LED's
- High light collection efficiency of >85%
- Diffuse output surface for improved beam uniformity
- Precision moulded in optical grade Polycarbonate for thermal stability and system durability
- Part of the Polymer Optics "Modular LED Optics"[®] range

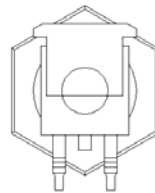

Typical dimensional tolerances to
+/-0.2mm

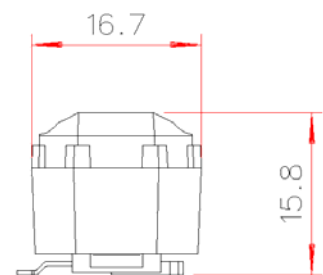
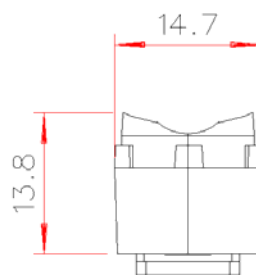
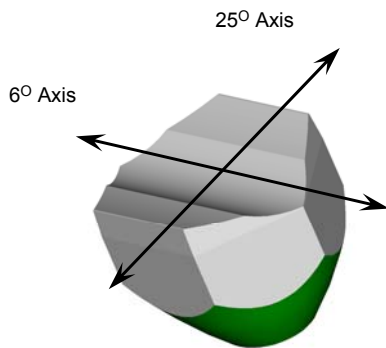

Polymer Optics "Modular LED Optics"[®] design, based on a hexagonal format, allows maximum packing density and assembly flexibility

Supplied with Holder (Part No. 182) to mount optics directly on to the Moonstone LED. Holder locates on LED package to ensure correct optical alignment



Our Focus is in Plastics

Polymer Optics Ltd.

6 Kiln Ride, Wokingham,
Berks., RG40 3JL, England
Tel/Fax: +44 (0) 1189 893341
www.polymer-optics.co.uk

Diffuse 25 Degree Collimator Lens for Avago Moonstone LEDs - Part No. 219



- Designed for Avago Moonstone High Power LED's
- High light collection efficiency of >85%
- Diffuse output surface for improved beam uniformity
- Precision moulded in optical grade Polycarbonate for thermal stability and system durability
- Part of the Polymer Optics "Modular LED Optics"[®] range

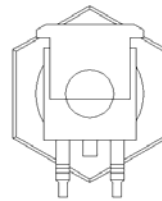
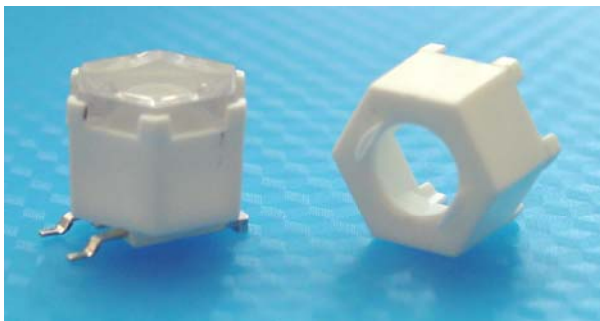

Typical dimensional tolerances
to +/-0.2mm

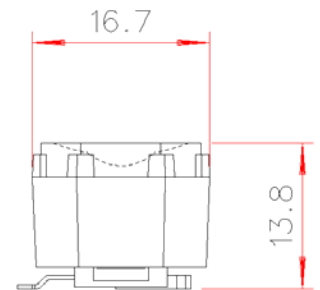
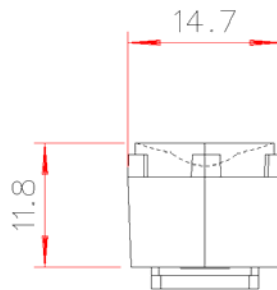

Polymer Optics "Modular LED Optics"[®] design, based on a hexagonal format, allows maximum packing density and assembly flexibility

Supplied with Holder (Part No. 182) to mount optics directly on to the Moonstone LED. Holder locates on LED package to ensure correct optical alignment



**Polymer
Optics
Limited**

Our Focus is in Plastics

Polymer Optics Ltd.

6 Kiln Ride, Wokingham,
Berks., RG40 3JL, England
Tel/Fax: +44 (0) 1189 893341
www.polymer-optics.co.uk

Lens Holder for Avago Moonstone LEDs - Part No. 182

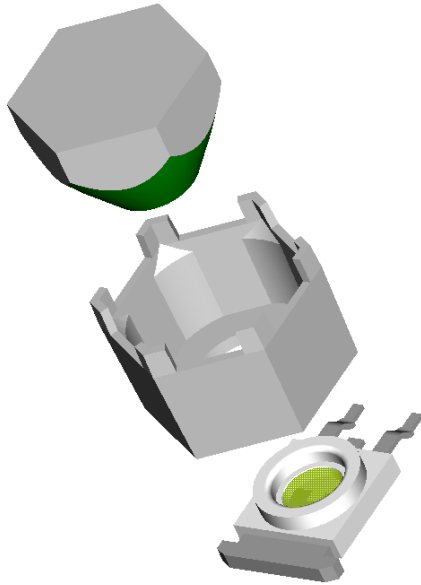

- Designed for use with Polymer Optics “Modular LED Optics”[®] and custom Polymer Optics designs
- Designed for Avago Moonstone High Power LED’s
- High light collection efficiency of >85%
- Precision moulded in optical grade Polycarbonate for thermal stability and system durability
- Part of the Polymer Optics “Modular LED Optics”[®] range

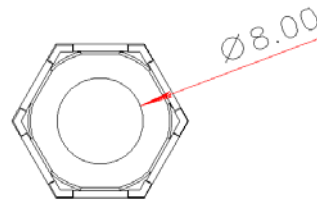

Typical dimensional tolerances to +/-0.2mm

Polymer Optics “Modular LED Optics”[®] design, based on a hexagonal format, allows maximum packing density and assembly flexibility

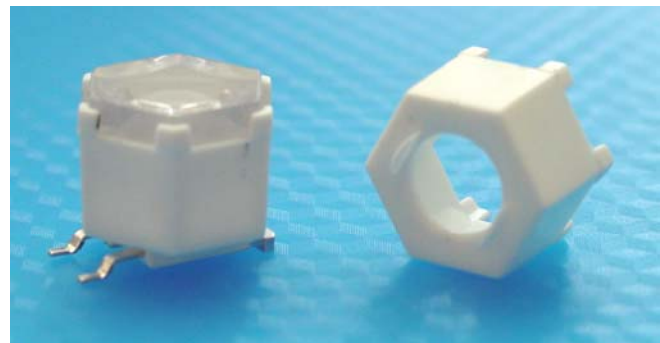
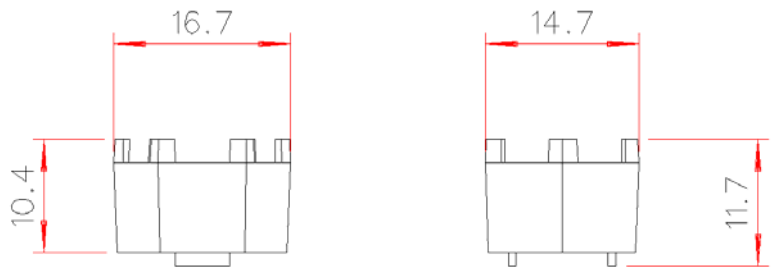
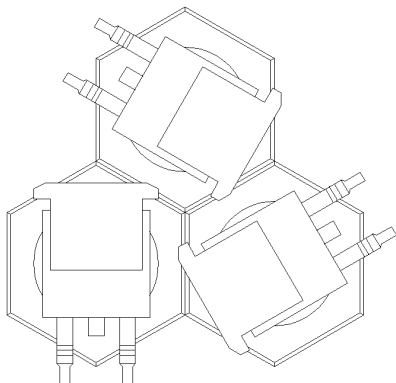

Due to continuous product improvement, POL reserve the right to change specifications without notice.

© Copyright Polymer Optics Limited 2008





Our Focus is in Plastics

Polymer Optics Ltd.

6 Kiln Ride, Wokingham,
Berks., RG40 3JL, England
Tel/Fax: +44 (0) 1189 893341
www.polymer-optics.co.uk

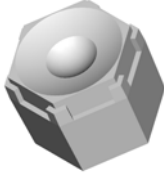
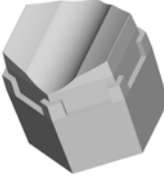
POL Avago Moonstone Optics Product Summary and Price List

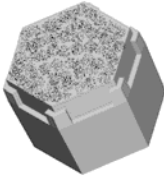
Product Image	Description	Usage	100-1K Batches	1K-5K Batches	5K-10K Batches	10K+ Batches
 170/182	6° Collimator + Avago Holder	Avago Moonstone High Power LED	£1.25	£0.98	£0.77	£0.72
 171/182	25° Collimator + Avago Holder	Avago Moonstone High Power LED	£1.25	£0.98	£0.77	£0.72
 172/182	6°x25° Line + Avago Holder	Avago Moonstone High Power LED	£1.25	£0.98	£0.77	£0.72
 173/182	Concentrator + Avago Holder	Avago Moonstone High Power LED	£1.25	£0.98	£0.77	£0.72
 186/182	Diffuse 6° Collimator + Avago Holder	Avago Moonstone High Power LED	£1.25	£0.98	£0.77	£0.72

A minimum order value applies of £50+shipping - All prices “ex-works”

Please contact POL for quotations on higher volumes and custom variants





Our Focus is in Plastics

Polymer Optics Ltd.

6 Kiln Ride, Wokingham,
Berks., RG40 3JL, England
Tel/Fax: +44 (0) 1189 893341
www.polymer-optics.co.uk

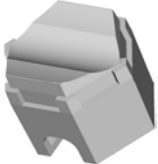
POL Avago Moonstone Optics Product Summary and Price List

Product Image	Description	Usage	100-1K Batches	1K-5K Batches	5K-10K Batches	10K+ Batches
 198/182	15° Collimator + Avago Holder	Avago Moonstone High Power LED	£1.25	£0.98	£0.77	£0.72
 218/182	Diffuse 6°x25° Line + Avago Holder	Avago Moonstone High Power LED	£1.25	£0.98	£0.77	£0.72
 219/182	Diffuse 25° Collimator + Avago Holder	Avago Moonstone High Power LED	£1.25	£0.98	£0.77	£0.72

A minimum order value applies of £50+shipping - All prices “ex-works”

Please contact POL for quotations on higher volumes and custom variants