



Our Focus is in Plastics

Polymer Optics Ltd.

6 Kiln Ride, Wokingham,
Berks., RG40 3JL, England
Tel/Fax: +44 (0) 1189 893341
www.polymer-optics.co.uk

6 Degree XR-E Collimator Lens - Part No. 170



- Specifically designed for Cree XR-E and XR-C High Power LEDs
- High light collection efficiency of >85%
- Precision moulded in optical grade Polycarbonate for thermal stability and system durability
- Part of the Polymer Optics “Modular LED Optics”® range

Polymer Optics “Modular LED Optics”® design, based on a hexagonal format, allows maximum packing density and assembly flexibility

Supplied with Holder (Part No. 147) to mount optics directly on to PCB’s. Holder locates on LED package to ensure correct alignment

Typical dimensional tolerances to +/-0.2mm

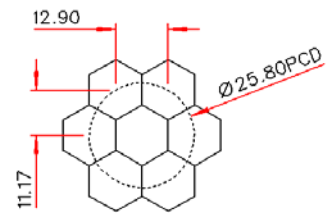

NESTED COMPONENTS ON 25,8MM PCD

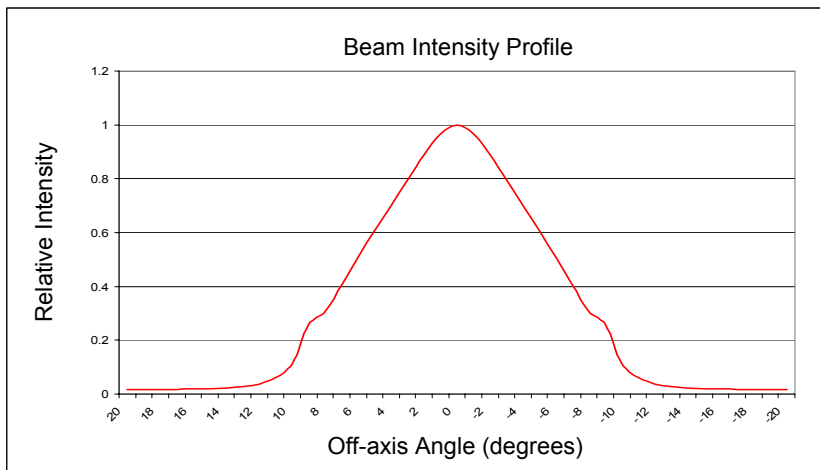
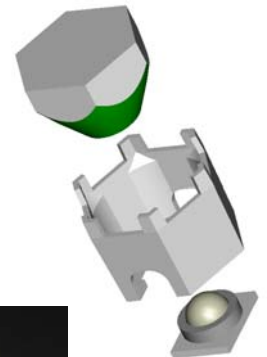
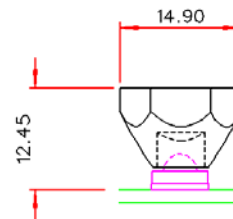
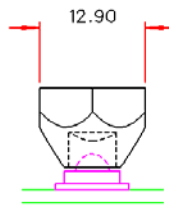
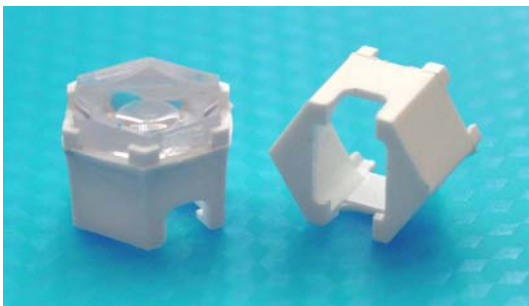

Due to continuous product improvement, POL reserve the right to change specifications without notice.



**Polymer
Optics
Limited**

Our Focus is in Plastics

Polymer Optics Ltd.

6 Kiln Ride, Wokingham,
Berks., RG40 3JL, England
Tel/Fax: +44 (0) 1189 893341
www.polymer-optics.co.uk

6 Degree Diffuse XR-E Collimator Lens - Part No. 186

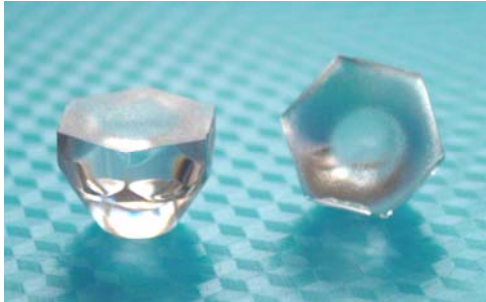

- Specifically designed for Cree XR-E and XR-C High Power LEDs
- High light collection efficiency of >85%
- Precision moulded in optical grade Polycarbonate for thermal stability and system durability
- Part of the Polymer Optics “Modular LED Optics”® range

Polymer Optics “Modular LED Optics”® design, based on a hexagonal format, allows maximum packing density and assembly flexibility

Supplied with Holder (Part No. 147) to mount optics directly on to PCB’s. Holder locates on LED package to ensure correct alignment

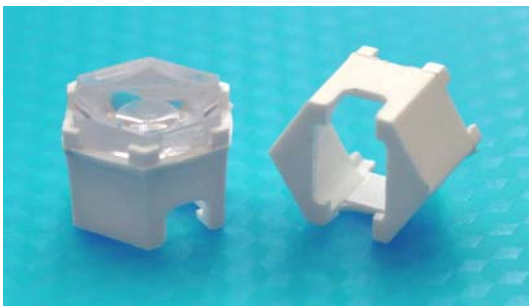

Typical dimensional tolerances to +/-0.2mm

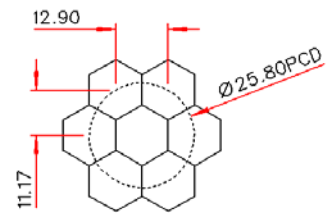
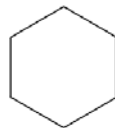

NESTED COMPONENTS ON 25,8MM PCD

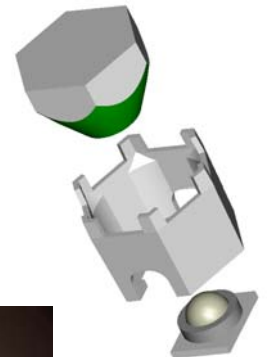
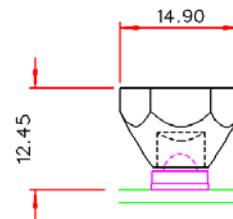
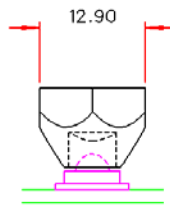

The latest Cree XR-E die technology, in some applications, produces a slightly square beam profile. This is due to the precise optical handling characteristics of the POL LED optics range.



To remove this potential issue, POL have introduced the new 186 optic which diffuses the square die form of the LED into a more uniform round beam with minimal increase in the collimation divergence angle

The rest of the POL range of LED optics which provide wider angles, beam concentration or other beam profile functions all provide similar beam averaging within the optic itself.

Due to continuous product improvement, POL reserve the right to change specifications without notice.



**Polymer
Optics
Limited**

Our Focus is in Plastics

Polymer Optics Ltd.

6 Kiln Ride, Wokingham,
Berks., RG40 3JL, England
Tel/Fax: +44 (0) 1189 893341
www.polymer-optics.co.uk

25 Degree XR-E Collimator Lens - Part No. 171



- Specifically designed for Cree XR-E and XR-C High Power LEDs
- High light collection efficiency of >85%
- Precision moulded in optical grade Polycarbonate for thermal stability and system durability
- Part of the Polymer Optics “Modular LED Optics”® range

Polymer Optics “Modular LED Optics”® design, based on a hexagonal format, allows maximum packing density and assembly flexibility

Supplied with Holder (Part No. 147) to mount optics directly on to PCB’s. Holder locates on LED package to ensure correct alignment

Typical dimensional tolerances to +/-0.2mm

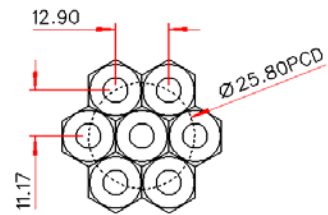

NESTED COMPONENTS ON 25,8MM PCD

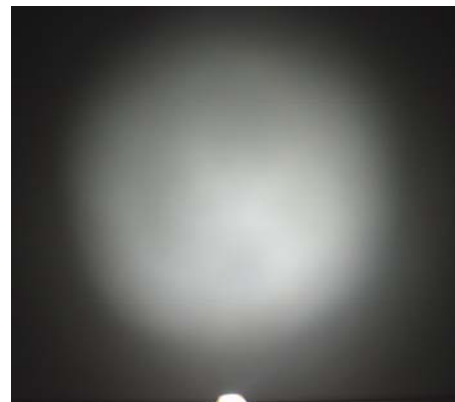
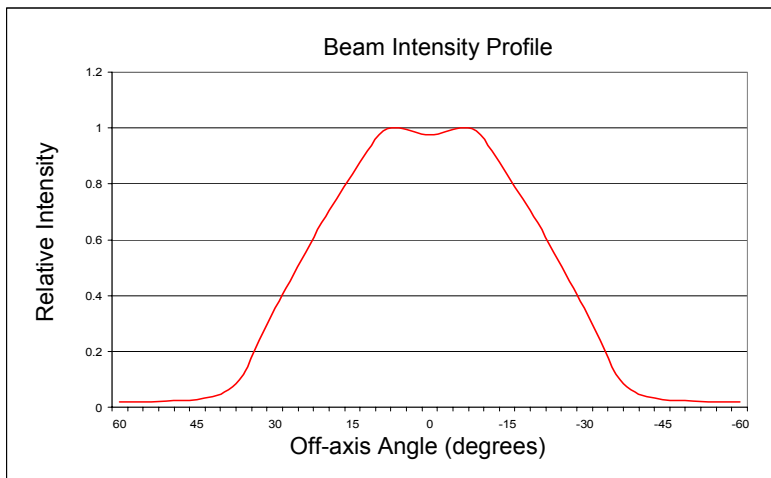
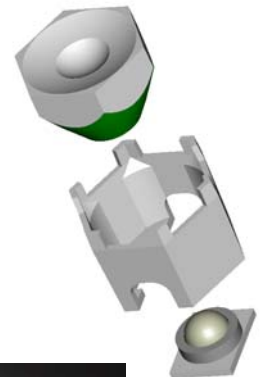
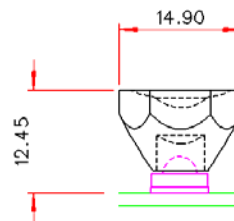
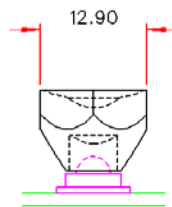
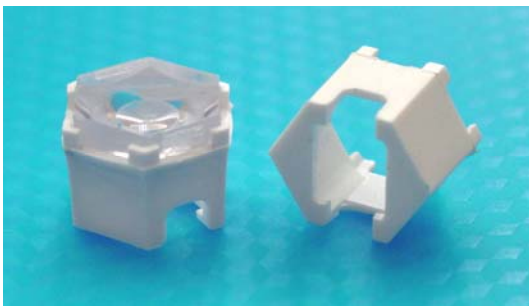

Due to continuous product improvement, POL reserve the right to change specifications without notice.

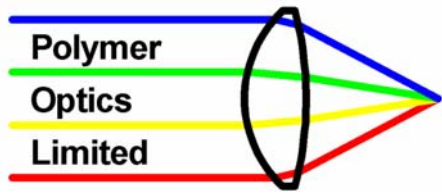

Our Focus is in Plastics

Polymer Optics Ltd.

6 Kiln Ride, Wokingham,
Berks., RG40 3JL, England
Tel/Fax: +44 (0) 1189 893341
www.polymer-optics.co.uk

6x25 Degree XR-E Line Lens - Part No. 172

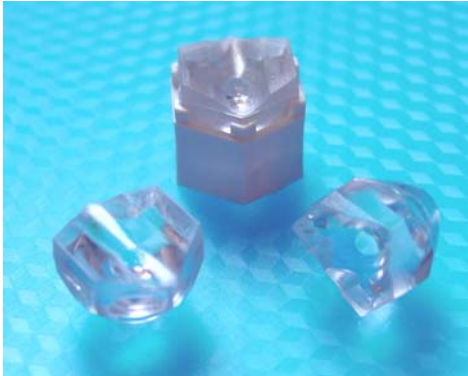

- Specifically designed for Cree XR-E and XR-C High Power LEDs
- High light collection efficiency of >85%
- Precision moulded in optical grade Polycarbonate for thermal stability and system durability
- Part of the Polymer Optics “Modular LED Optics”® range

Polymer Optics “Modular LED Optics”® design, based on a hexagonal format, allows maximum packing density and assembly flexibility

Supplied with Holder (Part No. 147) to mount optics directly on to PCB's. Holder locates on LED package to ensure correct alignment

Typical dimensional tolerances to +/-0.2mm

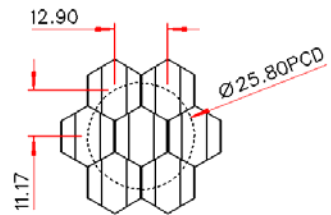

NESTED COMPONENTS ON 25,8MM PCD

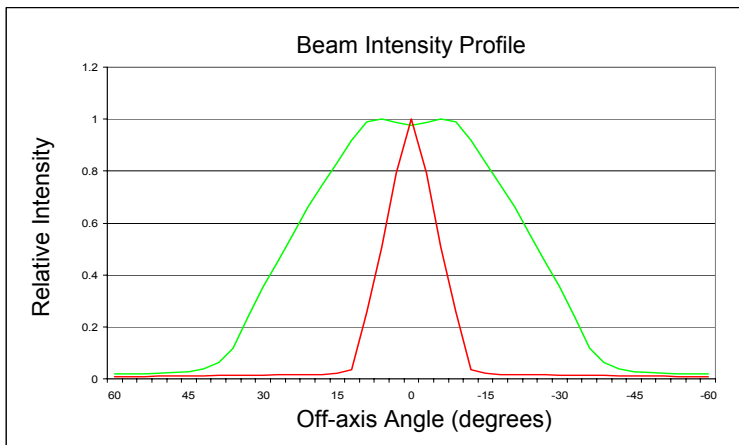
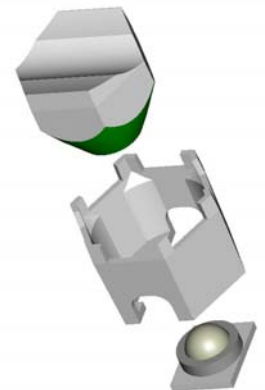
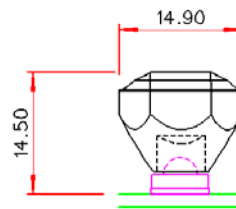
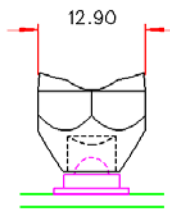
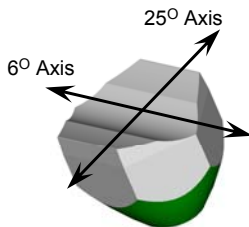
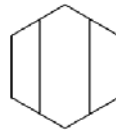

Due to continuous product improvement, POL reserve the right to change specifications without notice.



Our Focus is in Plastics

Polymer Optics Ltd.

6 Kiln Ride, Wokingham,
Berks., RG40 3JL, England
Tel/Fax: +44 (0) 1189 893341
www.polymer-optics.co.uk

Single Cell XR-E Concentrator Lens - Part No. 173

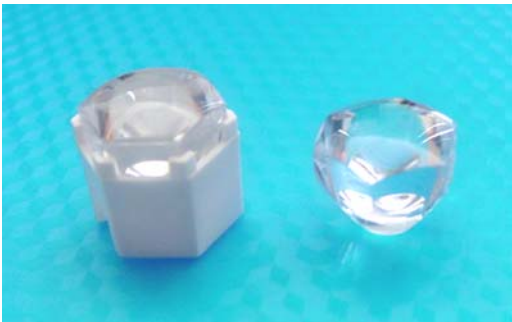

- Specifically designed for Cree XR-E and XR-C High Power LEDs
- High light collection efficiency of >85%
- Precision moulded in optical grade Polycarbonate for thermal stability and system durability
- Part of the Polymer Optics “Modular LED Optics”® range

Polymer Optics “Modular LED Optics”® design, based on a hexagonal format, allows maximum packing density and assembly flexibility

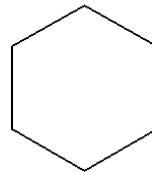

Supplied with Holder (Part No. 147) to mount optics directly on to PCB's. Holder locates on LED package to ensure correct alignment

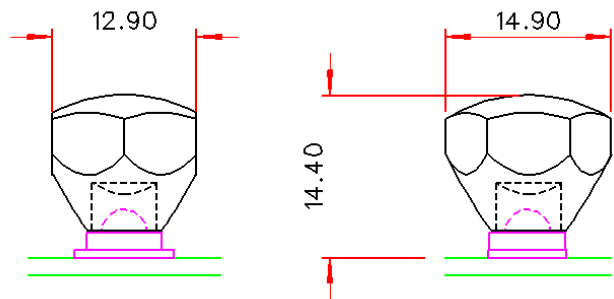
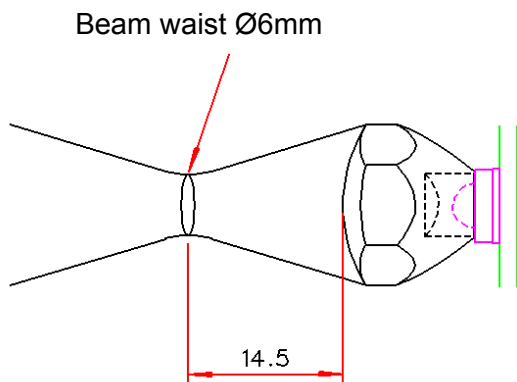

Typical Applications:

- Beam insertion into optical fibre bundles
- Beam insertion into edge of lightguides
- High intensity illumination of small objects for inspection and microscopy





Our Focus is in Plastics

Polymer Optics Ltd.

6 Kiln Ride, Wokingham,
Berks., RG40 3JL, England
Tel/Fax: +44 (0) 1189 893341
www.polymer-optics.co.uk

15 Degree XR-E Collimator Lens - Part No. 198



- Specifically designed for Cree XR-E and XR-C High Power LEDs
- High light collection efficiency of >85%
- Precision moulded in optical grade Polycarbonate for thermal stability and system durability
- Part of the Polymer Optics “Modular LED Optics”® range

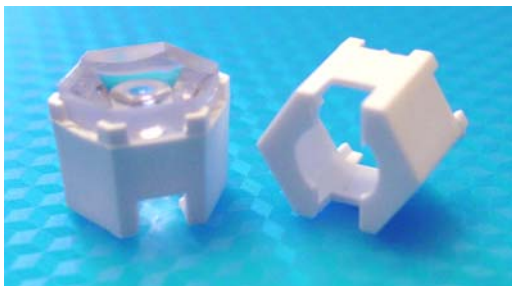

Typical dimensional tolerances to +/-0.2mm

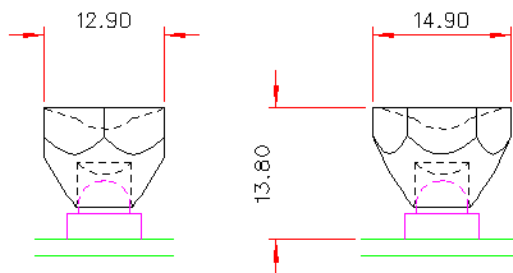
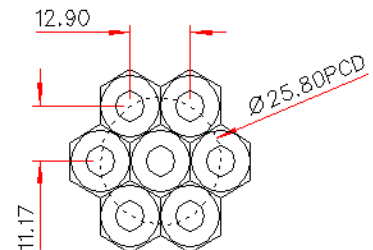
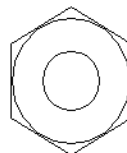

Polymer Optics “Modular LED Optics”® design, based on a hexagonal format, allows maximum packing density and assembly flexibility

Supplied with Holder (Part No. 147) to mount optics directly on to PCB's. Holder locates on LED package to ensure correct alignment



Our Focus is in Plastics

Polymer Optics Ltd.

6 Kiln Ride, Wokingham,
Berks., RG40 3JL, England
Tel/Fax: +44 (0) 1189 893341
www.polymer-optics.co.uk

Diffuse 6x25 Degree XR-E Collimator Lens - Part No. 218

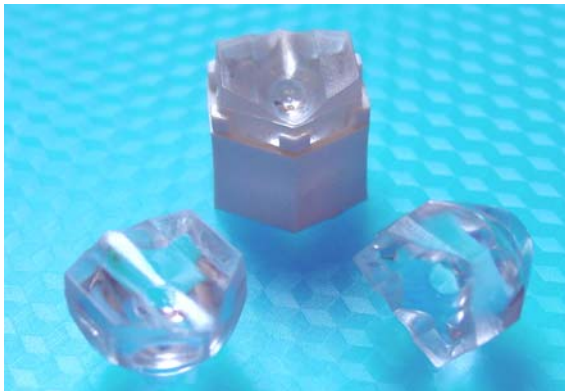

- Specifically designed for Cree XR-E and XR-C High Power LEDs
- High light collection efficiency of >85%
- Diffuse output surface for improved beam uniformity
- Precision moulded in optical grade Polycarbonate for thermal stability and system durability
- Part of the Polymer Optics “Modular LED Optics”[®] range

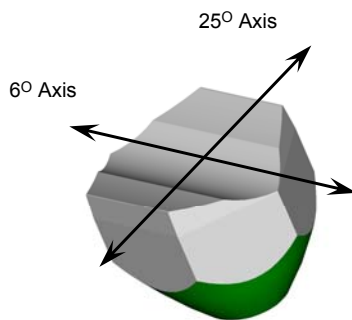

Typical dimensional tolerances to +/-0.2mm

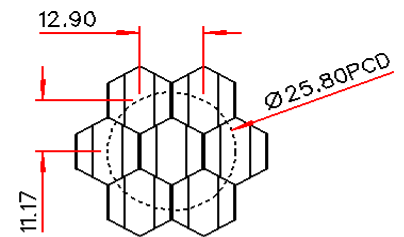
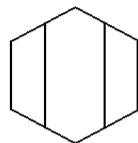

NESTED COMPONENTS ON 25,8MM PCD

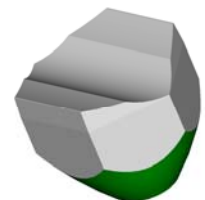
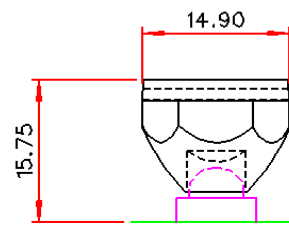
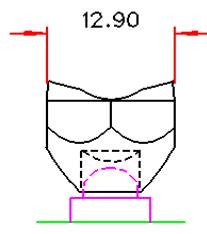

Polymer Optics “Modular LED Optics”[®] design, based on a hexagonal format, allows maximum packing density and assembly flexibility

Supplied with Holder (Part No. 147) to mount optics directly on to PCB's. Holder locates on LED package to ensure correct alignment



Our Focus is in Plastics

Polymer Optics Ltd.

6 Kiln Ride, Wokingham,
Berks., RG40 3JL, England
Tel/Fax: +44 (0) 1189 893341
www.polymer-optics.co.uk

Diffuse 25 Degree XR-E Collimator Lens - Part No. 219



- Specifically designed for Cree XR-E and XR-C High Power LEDs
- High light collection efficiency of >85%
- Diffuse output surface for improved beam uniformity
- Precision moulded in optical grade Polycarbonate for thermal stability and system durability
- Part of the Polymer Optics “Modular LED Optics”® range

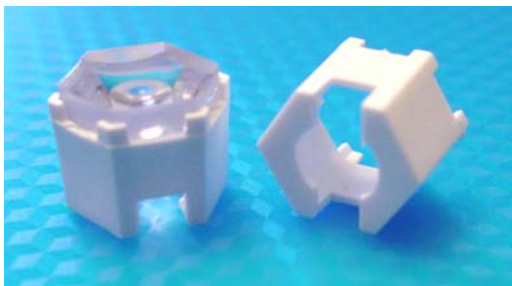

Typical dimensional tolerances to +/-0.2mm

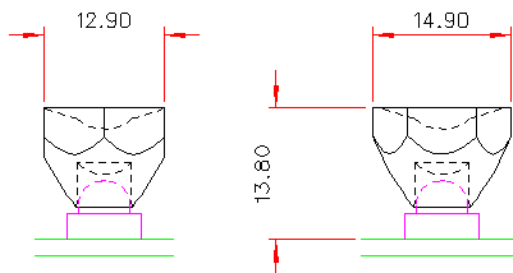
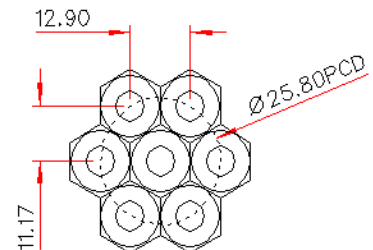
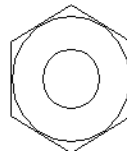

Polymer Optics “Modular LED Optics”® design, based on a hexagonal format, allows maximum packing density and assembly flexibility

Supplied with Holder (Part No. 147) to mount optics directly on to PCB's. Holder locates on LED package to ensure correct alignment



Our Focus is in Plastics

Polymer Optics Ltd.

6 Kiln Ride, Wokingham,
Berks., RG40 3JL, England
Tel/Fax: +44 (0) 1189 893341
www.polymer-optics.co.uk

Cree XLamp LED Lens Holder - Part No. 147

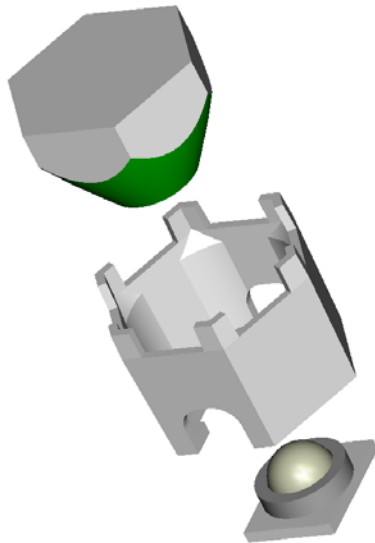

- Designed for use with Polymer Optics “Modular LED Optics”[®] and custom Polymer Optics designs
- Designed to operate with Cree XR-E High Power LEDs
- Simply mounts onto PCB and self-aligns to LED
- Precision moulded in optical grade Polycarbonate for thermal stability and system durability
- Part of the Polymer Optics “Modular LED Optics”[®] range

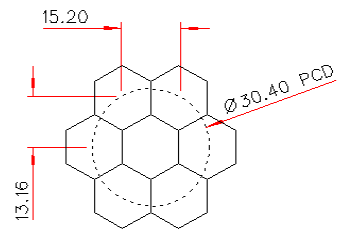
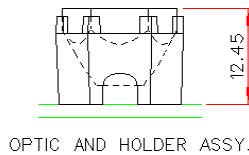

NESTED COMPONENTS ON 30.4MM PCD
Typical dimensional tolerances to +/-0.2mm

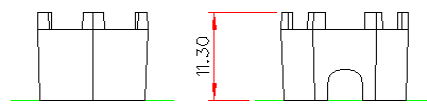
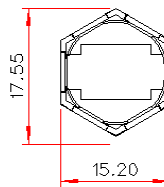

Polymer Optics “Modular LED Optics”[®] design, based on a hexagonal format, allows maximum packing density and assembly flexibility

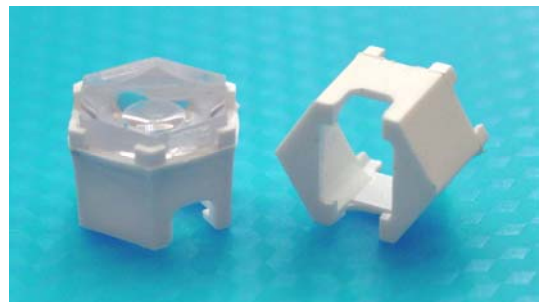
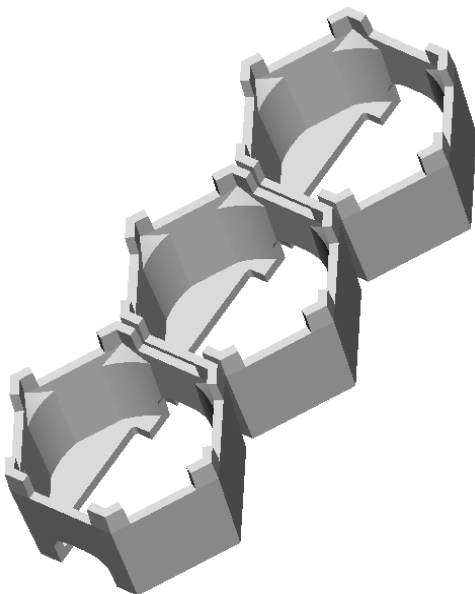

Due to continuous product improvement, POL reserve the right to change specifications without notice.

© Copyright Polymer Optics Limited 2008



Our Focus is in Plastics

Polymer Optics Ltd.

6 Kiln Ride, Wokingham,
Berks., RG40 3JL, England
Tel/Fax: +44 (0) 1189 893341
www.polymer-optics.co.uk

Cree XR-E Optics Product Summary and Price List

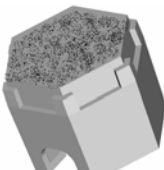
Product Image	Description	Usage	100-1K Batches	1K-5K Batches	5K-10K Batches	10K+ Batches
 170/147	6° Collimator + Std Holder	Cree XR-E High Power LED	£1.25	£0.98	£0.77	£0.72
 171/147	25° Collimator + Std Holder	Cree XR-E High Power LED	£1.25	£0.98	£0.77	£0.72
 172/147	6°x25° Line + Std Holder	Cree XR-E High Power LED	£1.25	£0.98	£0.77	£0.72
 173/147	Concentrator + Std Holder	Cree XR-E High Power LED	£1.25	£0.98	£0.77	£0.72
 186/147	Diffuse 6° Collimator + Std Holder	Cree XR-E High Power LED	£1.25	£0.98	£0.77	£0.72

A minimum order value applies of £50+shipping - All prices “ex-works”

Please contact POL for quotations on higher volumes and custom variants





Our Focus is in Plastics

Polymer Optics Ltd.

6 Kiln Ride, Wokingham,
Berks., RG40 3JL, England
Tel/Fax: +44 (0) 1189 893341
www.polymer-optics.co.uk

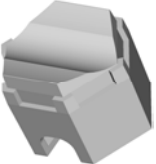
Cree XR-E Optics Product Summary and Price List

Product Image	Description	Usage	100-1K Batches	1K-5K Batches	5K-10K Batches	10K+ Batches
 198/147	15° Collimator + Std Holder	Cree XR-E High Power LED	£1.25	£0.98	£0.77	£0.72
 218/147	Diffuse 6°x25° Line + Std Holder	Cree XR-E High Power LED	£1.25	£0.98	£0.77	£0.72
 219/147	Diffuse 25° Collimator + Std Holder	Cree XR-E High Power LED	£1.25	£0.98	£0.77	£0.72

A minimum order value applies of £50+shipping - All prices “ex-works”

Please contact POL for quotations on higher volumes and custom variants