

*Our Focus is in Plastics*

**Polymer Optics Ltd.**

6 Kiln Ride, Wokingham,  
Berks., RG40 3JL, England  
Tel/Fax: +44 (0) 1189 893341  
www.polymer-optics.co.uk

**Narrow Angle LED Colour Mixer Assembly - Part No. 157**

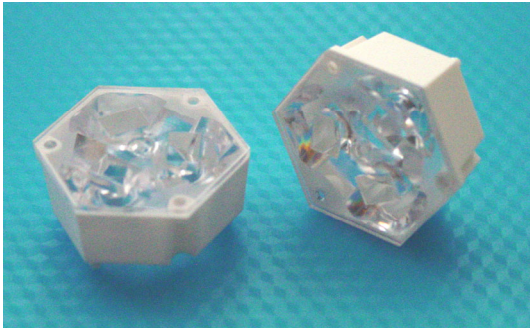

- Suitable for Edison Edixeon Emitter LEDs
- High collection efficiency and narrow angle beam output
- Precision moulded in optical grade Polycarbonate for thermal stability and system durability
- Part of the Polymer Optics “Modular LED Optics”® range

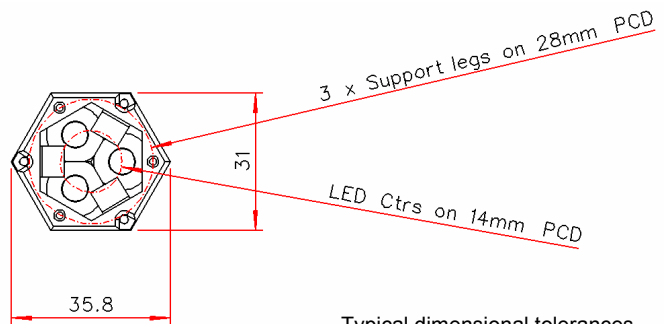
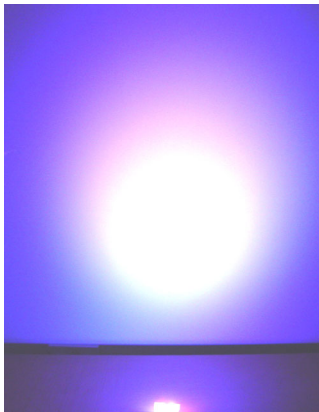

Typical dimensional tolerances to +/-0.2mm

- POL's novel hexagonal design allows the optics to be clustered together to make larger narrow angle colour mixing arrays

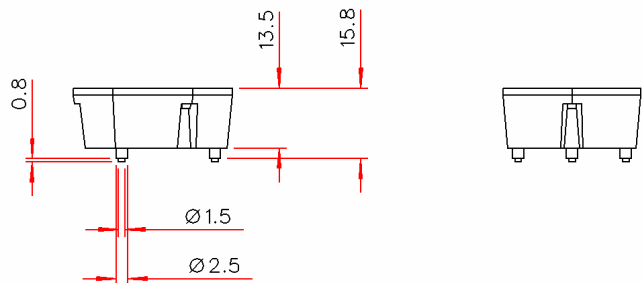
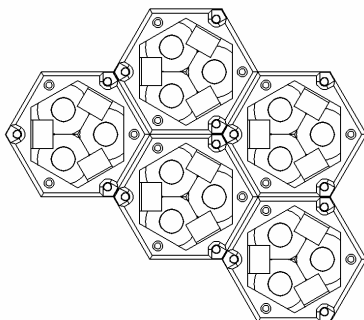

Due to continuous product improvement, POL reserve the right to change specifications without notice.

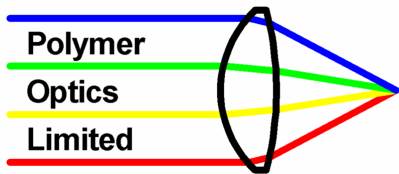

*Our Focus is in Plastics*

**Polymer Optics Ltd.**

6 Kiln Ride, Wokingham,  
Berks., RG40 3JL, England  
Tel/Fax: +44 (0) 1189 893341  
[www.polymer-optics.co.uk](http://www.polymer-optics.co.uk)

**Narrow Angle LED Colour Mixer Assembly - Part No. 157**

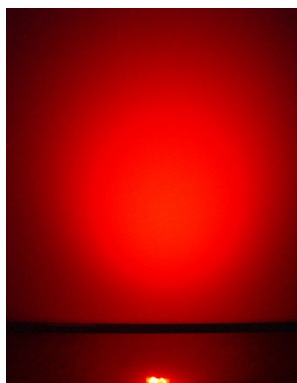
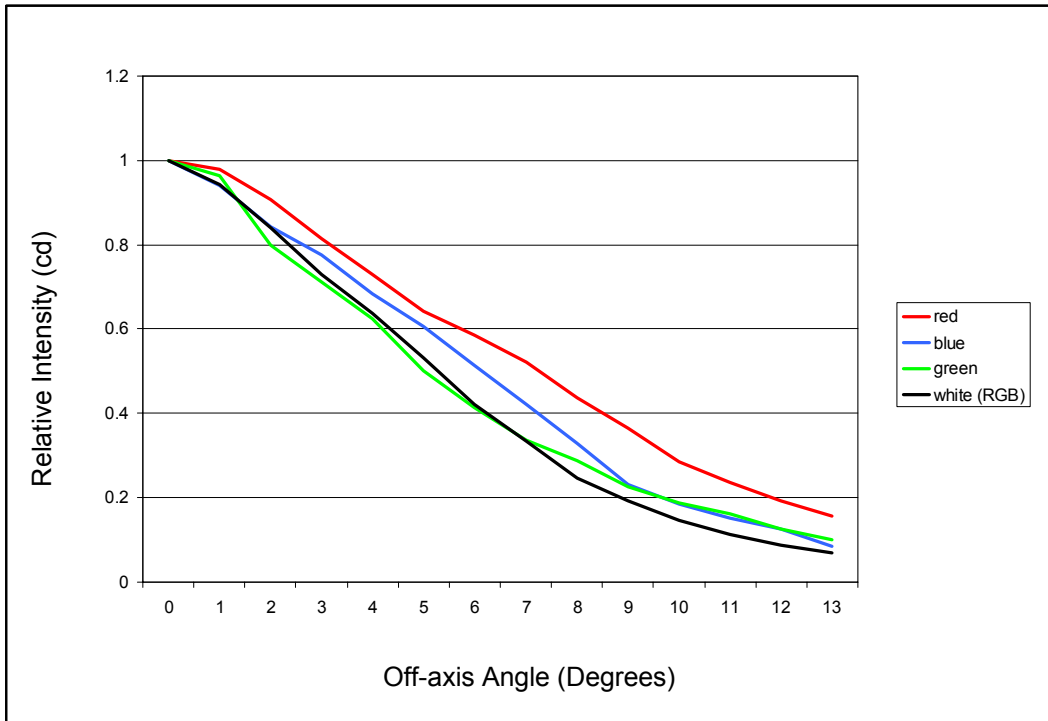

Red

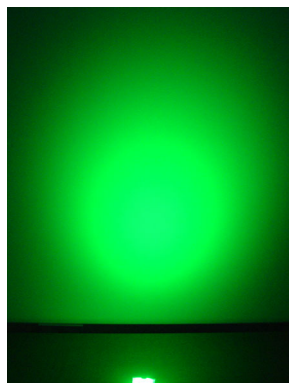

Green



Blue

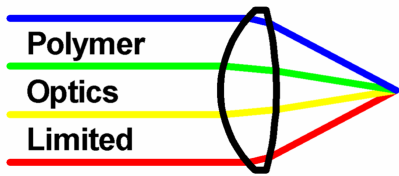

Polymer  
Optics  
Limited

*Our Focus is in Plastics*

**Polymer Optics Ltd.**

6 Kiln Ride, Wokingham,  
Berks., RG40 3JL, England  
Tel/Fax: +44 (0) 1189 893341  
[www.polymer-optics.co.uk](http://www.polymer-optics.co.uk)

### Narrow Angle LED Colour Mixer Assembly - Part No. 157

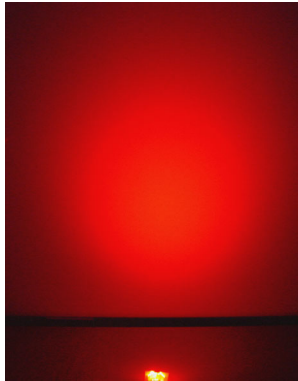

Red



Green

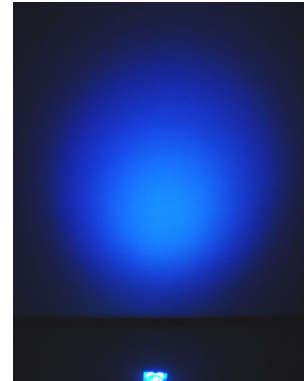

Blue



Red/Blue

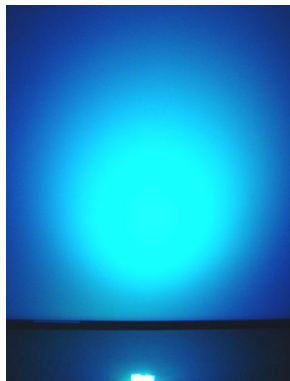

Green/Blue

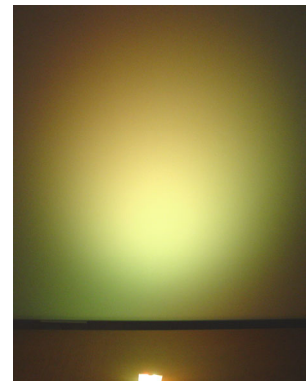

Red/Green

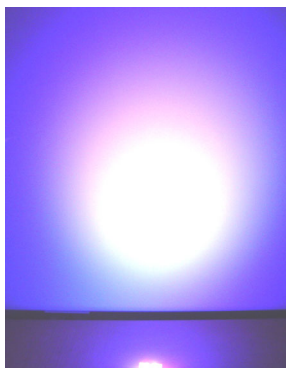

Red/Green/Blue

- Excellent colour mixing performance with single colour LED's even over short distances
- Narrow angle basic beam angle which can be converted to wider beam angles or elliptical profiles with POL converter optics and filters
- Can also be used with White LED's to improve bin mixing and reduce colour temperature variations

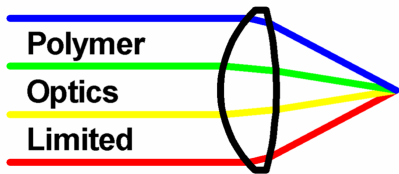

*Our Focus is in Plastics*

**Polymer Optics Ltd.**

6 Kiln Ride, Wokingham,  
Berks., RG40 3JL, England  
Tel/Fax: +44 (0) 1189 893341  
www.polymer-optics.co.uk

**Colour Mixer Universal MCPCB – Part No. 159**



- Universal MCPCB can be provided by POL to support customer prototyping and luminaire production using Edison Edixeon Emitter and Star LEDs
- Manufactured by Universal Science using Unilam substrates.
- 159 - MCPCB's can be supplied with Universal Science Bondline200 self-adhesive thermal gasket tape, die cut to the dimensions of the 159 - MCPCB.
- 157 - Colour Mixer Optics assembled onto the 159 - MCPCB's can be clustered into large arrays and linear formats.
- Part of the Polymer Optics "Modular LED Optics"® range

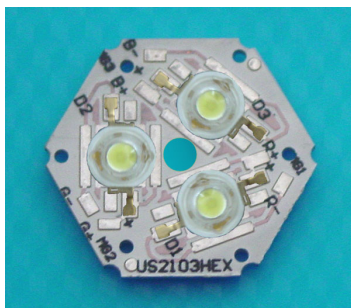
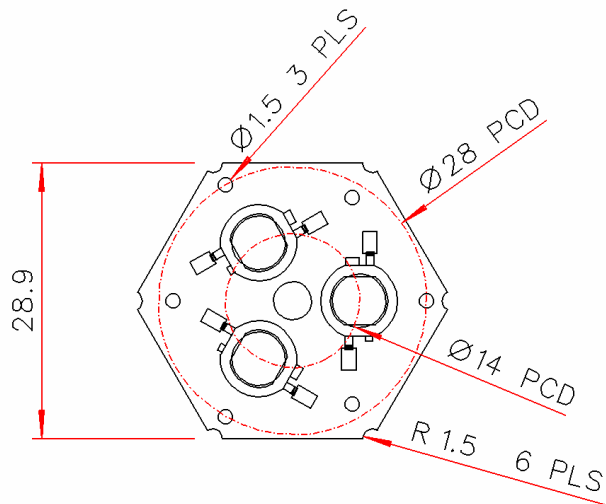
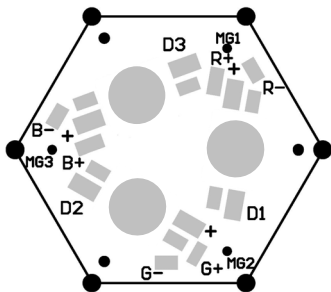

Edixeon Emitters on MCPCB



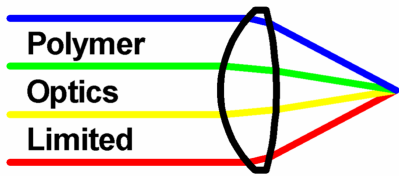

*Our Focus is in Plastics*

**Polymer Optics Ltd.**

6 Kiln Ride, Wokingham,  
Berks., RG40 3JL, England  
Tel/Fax: +44 (0) 1189 893341  
www.polymer-optics.co.uk

## Converter Optics for Narrow Angle LED Colour Mixer Assembly

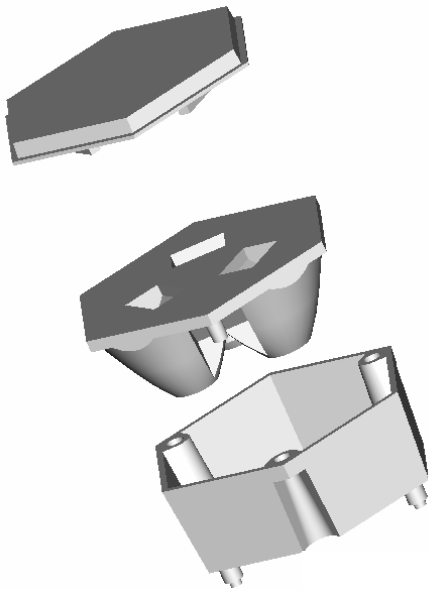

- Beam Converter Optics simply interference push fit onto the front of the 157 - Colour Mixer Optic.
- Precision moulded in optical grade PMMA acrylic for improved scratch resistance on the outside of the assembly.
- The Beam Converter Optics fit within the area of the 157- Colour Mixer Optic so the assemblies can still be arranged in close packed arrays.
- Flanged edge of the Beam Converter Optics allows bezels and cover plates to be located to the optical assembly for aesthetic product finishing.
- Part of the Polymer Optics “Modular LED Optics”<sup>®</sup> range

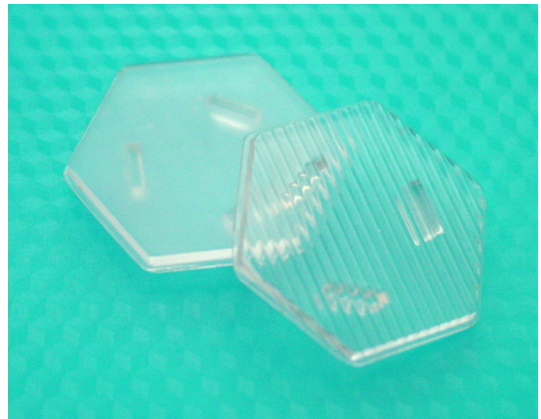
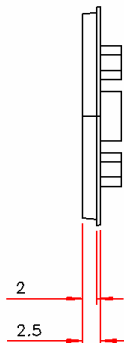
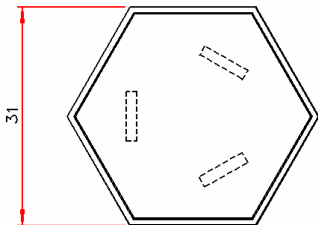

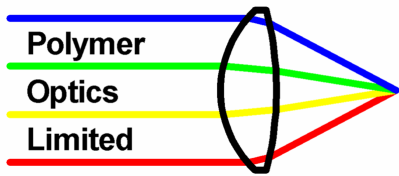

*Our Focus is in Plastics*

**Polymer Optics Ltd.**

6 Kiln Ride, Wokingham,  
Berks., RG40 3JL, England  
Tel/Fax: +44 (0) 1189 893341  
[www.polymer-optics.co.uk](http://www.polymer-optics.co.uk)

**Converter Optics for Narrow Angle LED Colour Mixer Assembly**

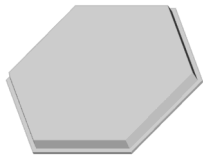

Plain Filter Holder - 160

- 160 - Plain Filter Holder can be used with Luminix Light Shaping Diffuser films to produce a wide range of beam profiles, available from POL or direct from [www.luminixco.com](http://www.luminixco.com).
- Other custom beam angles can be produced cost effectively from POL's modular production tooling. Please enquire for details

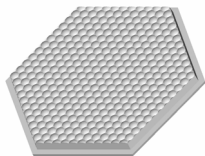

25 Deg Diffuser - 161

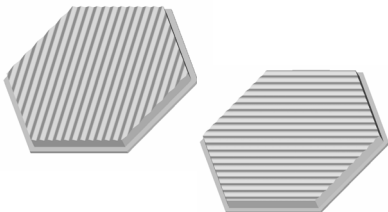
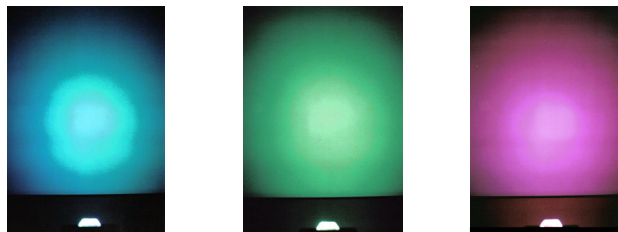

6 x 25 Deg Line Diffusers – 162 & 162B

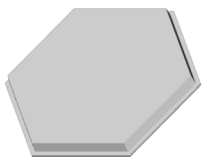
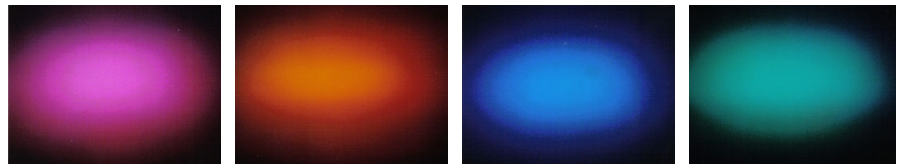

Soft Beam Diffuser - 163

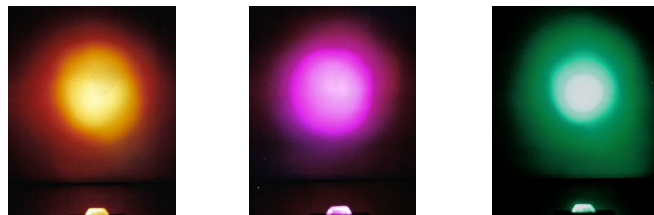

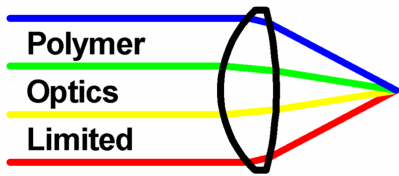

*Our Focus is in Plastics*

**Polymer Optics Ltd.**

6 Kiln Ride, Wokingham,  
Berks., RG40 3JL, England  
Tel/Fax: +44 (0) 1189 893341  
[www.polymer-optics.co.uk](http://www.polymer-optics.co.uk)

## Converter Optics for Narrow Angle LED Colour Mixer Assembly

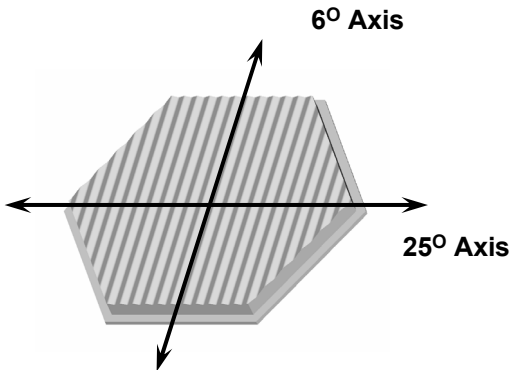

**6 x 25 Deg Line Diffusers – 162**

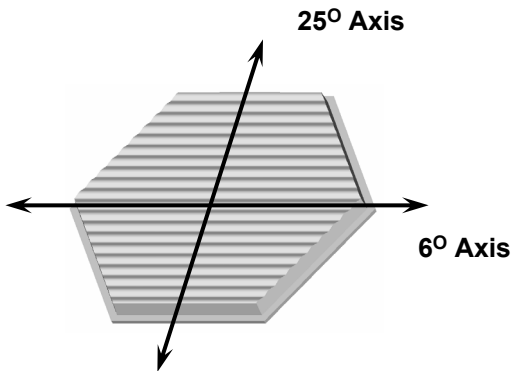

**6 x 25 Deg Line Diffusers – 162B**

6 x 25 Deg Line Diffusers is available in two versions, the 162 and the 162B

These diffusers have the same optical function, but allow the beam to be spread in either orthogonal direction.

The 162 version can be used where multiple rows of optics are used and a close packed narrow array is required, along the axis of the linear beam output.

The 162B version can be used where single row linear fittings are required with the optics close packed together with the hexagonal flats placed side by side.

These 6 x 25 Deg Line Diffusers can also be mixed in optical arrays to produce other overall beam effects.

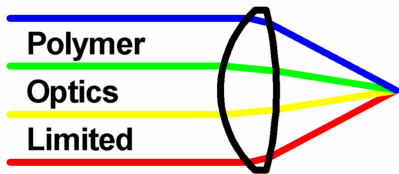



*Our Focus is in Plastics*

**Polymer Optics Ltd.**

6 Kiln Ride, Wokingham,  
Berks., RG40 3JL, England  
Tel/Fax: +44 (0) 1189 893341  
www.polymer-optics.co.uk

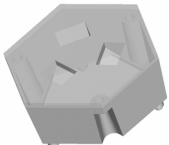
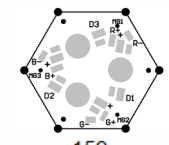
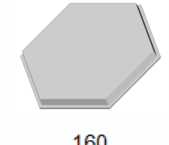
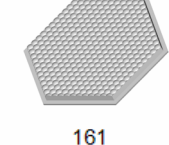
**Price List for Edison Narrow Angle LED Colour Mixer Range**

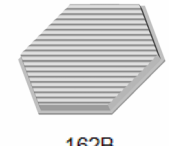
Product Image	Description	Usage	1-100 Batches	100-1K Batches	1K-5K Batches	5K-10K Batches	10K+ Batches
 157	6° Colour Mixer Collimator Assembly	Edixeon Emitters	*	£3.80	£3.60	£3.20	£3.00
 159	Hexagonal MCPCB for 157 Optic	Edixeon Emitters	£10.00	£2.00	£1.55	£1.35	£1.25
 160	Filter Holder	Fits to 157 Optic	*	£0.32	£0.30	£0.27	£0.25
 161	25° Beam Converter Optic	Fits to 157 Optic	*	£0.32	£0.30	£0.27	£0.25
 162	6°x25° Beam Converter Optic	Fits to 157 Optic	*	£0.32	£0.30	£0.27	£0.25
 162B	6°x25° Beam Converter Optic	Fits to 157 Optic	*	£0.32	£0.30	£0.27	£0.25

\* A minimum order value applies of £50+shipping - All prices "ex-works"

Please contact POL for quotations on higher volumes and custom variants

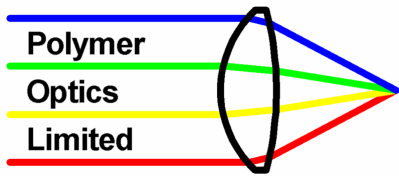

*Our Focus is in Plastics*

**Polymer Optics Ltd.**

6 Kiln Ride, Wokingham,  
Berks., RG40 3JL, England  
Tel/Fax: +44 (0) 1189 893341  
www.polymer-optics.co.uk

**Price List for Edison Narrow Angle LED Colour Mixer Range**

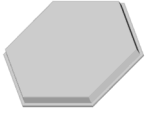
Product Image	Description	Usage	1-100 Batches	100-1K Batches	1K-5K Batches	5K-10K Batches	10K+ Batches
 163	Beam Diffuser Filter	Fits to 157 Optic	*	£0.32	£0.30	£0.27	£0.25

\* A minimum order value applies of £50+shipping - All prices “ex-works”

Please contact POL for quotations on higher volumes and custom variants